

Neigungsmesser - S0005



- mechanisch, amagnetisch, wartungsfrei, seewasserbeständig
- glyceringefüllt
- schock- und rüttelsicher nach BV 043/044
- hinterer Befestigungsrand





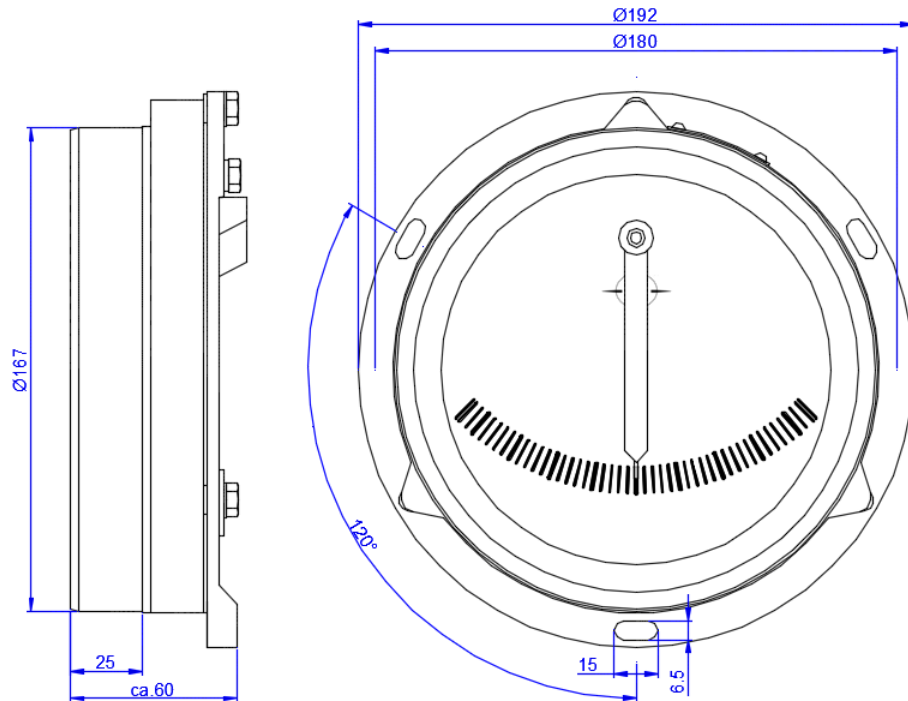





Einsatzbereiche Schiffbau, Marineschiffbau

Ausführungsvarianten	
Nenngröße	160
Nenndruck	6,6
Gewicht	4,8 kg (Bronze) 2,2 kg (Aluminium)
Betriebstemperatur	-20 - 100°C
NSN	6605-12-318-7583 6605-12-318-7582
Material	
Gehäuse	Aluminium 3.3555 Bronze 2.1052
Sichtscheibe	Einscheiben-Sicherheitsglas
Ziffernblatt	Gravoply
Zeiger	Messing 2.0321



Abmessungen

Farben

Gehäuse	Schwarz	RAL 9005	
Skalengrund	Weiß	RAL 9010	
Skalenbeschriftung	Schwarz	RAL 9005	
	Gelb	RAL 1021	
	Weiß	RAL 9010	
Zeigerfarbe	Leuchtfarbe	UVG 75 Grün	
	Schwarz	RAL 9005	
	Schwarz	RAL 9005	
	Gelb	RAL 1021	
	Leuchtfarbe	UVG 75 Grün	
	* weitere Farben auf Anfrage.		