

Pressure Gauge - M0024











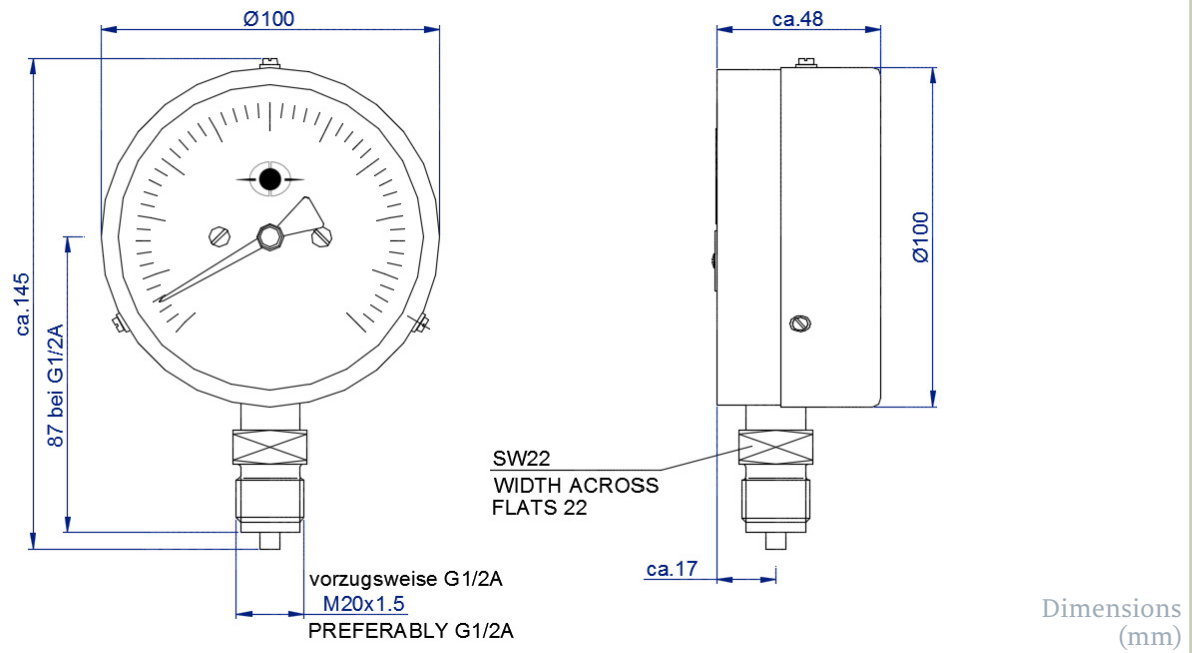









- as per DIN EN 837-1
- nominal size 100
- mechanical, antimagnetic, sea water resistant, maintenance free
- shock and vibration resistant as per BV 043/044
- motion work with dampened axis

Applications shipbuilding, naval shipbuilding, heating and air-conditioning technology, environmental and process technology, plant construction.

Media All types of fluids and gases that do not corrode copper alloys, solidify or have a high viscosity. (i.e. nitrogen, hydraulic oil)

Specifications		
connection	M16x1,5 M20x1,5 G1/2"A *other options on request	
connection position	bottom	
bourdon tube	c-shape < 80 bar < helix shape	
mounting position	90° *other options on request	
precision class	1 as per EN 837-1 *other options on request	
permanent pressure	100% of scale	
alternation pressure	90% of scale	
short time overpressure	130% of scale	
Technical Limitations		
nominal pressure	min -1 bar	max 400 bar
operating temperature	-20°C	
temperature influence	±0,4% FSO / 10K	
weight	0,9 kg	
Additional Options		
coloured sections on scale	red/yellow/green	
free from oil and grease	yes/no	
suitable for O ₂ application	yes/no	
throttle screw	yes/no	
bursting diaphragm	yes/no	
marking pointer	yes/no	
Material		
casing	brass	
wetted parts	copper alloys	
window	security glass, etched on one side	



Colours			
casing	black	RAL 9005	
	grey	RAL 7037	
frontal rim	black	RAL 9005	
	grey	RAL 7037	
scale background	white	RAL 9010	
	black	RAL 9005	
	fluorescent	UVG 75 green	
scale labels	yellow	RAL 1021	
	white	RAL 9010	
	fluorescent	UVG 75 green	
	black	RAL 9005	
pointer	black	RAL 9005	
	yellow	RAL 1021	
	fluorescent	UVG 75 green	
scale coloured sections	red	RAL 2002	
	yellow	RAL 1021	
	green	RAL 6018	
*more colour options on enquiry			