

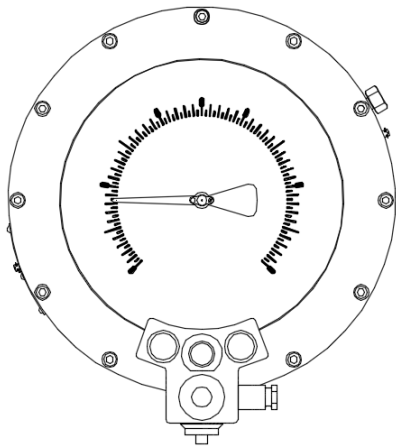







Depth Gauge - M0075



- nominal size: 250
- antimagnetic, maintenance-free
- shock and vibration resistant as per BV 043/044
- rear mounting rim
- with venting screw
- with illuminated scale

Applications Shipbuilding, naval shipbuilding,
Media water, sea water

Available Versions			
measuring element	bourdon tube		
process connection	G1/2"A, bottom		
accuracy class:	0,6 as per DIN EN 837-1		
weather protection	IP 54 as per DIN EN 60529		
electrical data	24VDC, max 0,16A / 3,84W		
short term overpressure	130% of scale		
Technical Limitations			
operation temperature	min		max
temperature influence	-20°C		+50°C
weight	9,6kg		±0,4% FSO / 10K
Material			
casing	aluminium		
wetted parts	copper alloy		
window	safety glass		
Colours			
casing	black	RAL 9005	
	grey	RAL 7037	
scale background	white	RAL 9010	
	black	RAL 9005	
	fluorescent	UVG 75 green	
scale labels	yellow	RAL 1021	
	fluorescent	UVG 75 green	
	black	RAL 9005	
pointer	black	RAL 9005	
	yellow	RAL 1021	
	fluorescent	UVG 75 green	
*other colour options on enquiry			

